



CAMP AE

Summer 24'

A Collection by S'23 Interns



MEET THE TEAM

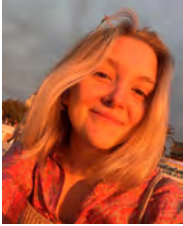

Deanna McNally

Marist College - Apparel Design

Womens Woven tops & dresses



Bria Royer

Marist College - BFA Fashion Design

Women's Denim Shorts and Skirts



Georgia DiRoberto

Kent State University - Fashion Design

Women's Sweaters

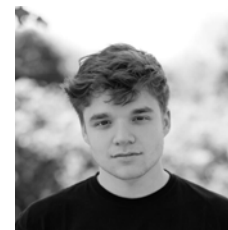

Luke Fisher

University of Missouri - Product Development

Men's Woven Bottoms



Mariana Rodriguez

SCAD - Fashion Design

Men's Woven Tops and Swim



Zach Spraggins

University of Oregon - BFA Product Design

Men's Knit Tops



53 KODAK PORTRA 400

54 KODAK PORTRA 400

55 KODAK PORTRA

51 KODAK PORTRA 400

52 KODAK PORTRA

53 KODAK PORTRA



CAMP LIFE CAMPERS' ESCAPE

COLOR STORY

CAMP LIFE CAMP LIFE



FABRICS

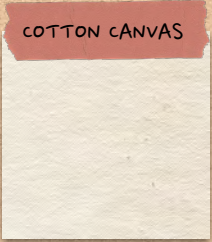
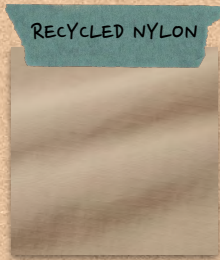
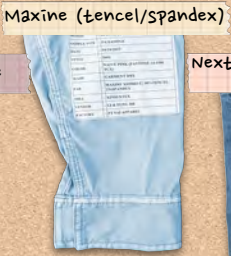



WOMENS DENIM SHORTS





WOMENS DENIM SHORTS

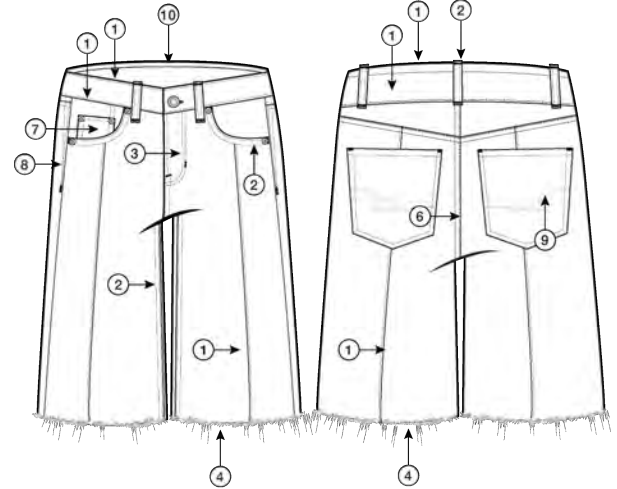
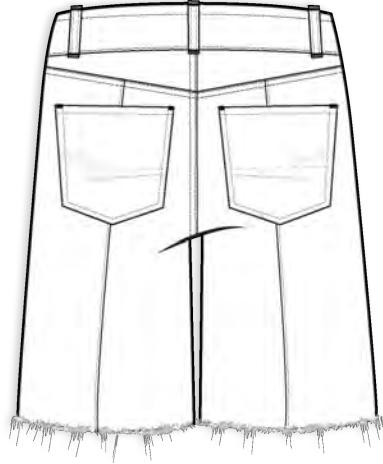
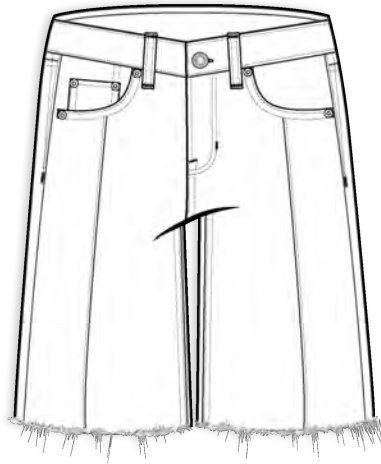

WASH STANDARD



WASH OPT 2



V-RISE LOW RISE SUPER BAGGY SHORT:

- 1 = EDGE STITCH
- 2 = 1/4" DBL NDL TOPSTITCH
- 3 = J-STITCH @ FLY (see diagram)
- 4 = FRAY HEM
- 5 = 1/4" DBL NDL YOKE STITCH
- 6 = 1/4" DBL NDL SAFETY STITCH
- 7 = COIN POCKET (see diagram)
- 8 = CORDSTITCH (see diagram)
- 9 = BACK POCKET (see diagram)
- 10 = INTERIOR CHAIN STITCH





WOMENS DENIM SHORTS

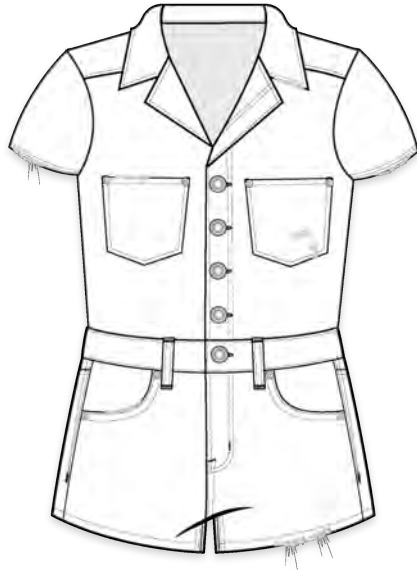

WASH VARIATIONS



RIPPED POCKET SHADOW

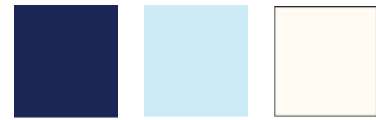



WOMENS WOVEN TOPS + DRESSES



Clean girl
Care free
Easy
Natural
Vintage Pretty

Wovens Trends



SKETCHES



V cross in front + back
 + narrower V in back
 ← Tie under arm
 ← side smocking detail
 + cute beach cover + dress



Italy hair

Maxi → Mini Zip off

← elastic waistband



zipper under ruffle
 zips off into mini skirt
 zipper sewn in to ruffle
 size of ruffle prominent enough to cover zip but not too big



Zip off first layer
 ← Layer OTT above ruff Mesh
 → ruffles on this

• Interchangeable skirts?
 solid + floral?
 • zip off skirts yet in a femme aesthetic



• Dainty ruffle but enough to cover zipper
 • Double layer? mesh w/ lining?



← asym? hem



Nylon Coil Separating Zipper





SKETCHES



- cropped resort shirt
 - oversized
 - OTT on pockets + Lapel Lace
 - pearl buttons to make it look more femme
- zig zag embroidery

The lived in woven stripe

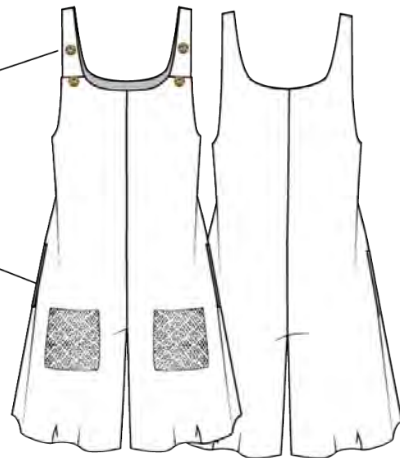

- new take on fit & f
- Drawstring channel used to achieve different fit
- To diff bust sizes/len comfort
- adjustability under bust

Just elastic instead of channel/ties





CADS



Maxine tencel

1	100% TENCEL
2	100% TENCEL
3	100% TENCEL
4	100% TENCEL
5	100% TENCEL
6	100% TENCEL
7	100% TENCEL
8	100% TENCEL
9	100% TENCEL
10	100% TENCEL
11	100% TENCEL
12	100% TENCEL
13	100% TENCEL
14	100% TENCEL
15	100% TENCEL
16	100% TENCEL
17	100% TENCEL
18	100% TENCEL
19	100% TENCEL
20	100% TENCEL
21	100% TENCEL
22	100% TENCEL
23	100% TENCEL
24	100% TENCEL
25	100% TENCEL
26	100% TENCEL
27	100% TENCEL
28	100% TENCEL
29	100% TENCEL
30	100% TENCEL
31	100% TENCEL
32	100% TENCEL
33	100% TENCEL
34	100% TENCEL
35	100% TENCEL
36	100% TENCEL
37	100% TENCEL
38	100% TENCEL
39	100% TENCEL
40	100% TENCEL
41	100% TENCEL
42	100% TENCEL
43	100% TENCEL
44	100% TENCEL
45	100% TENCEL
46	100% TENCEL
47	100% TENCEL
48	100% TENCEL
49	100% TENCEL
50	100% TENCEL



Raya Stripe

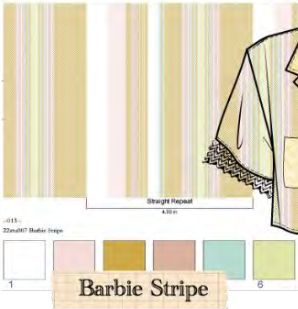
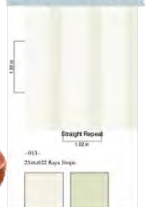

Barbie Stripe



Mika Floral



Kylie



Krista Crepe



CAMP LIFE CAMP LIFE CAMP LIFE CAMP LIFE

WOMENS SWEATERS

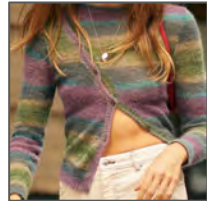
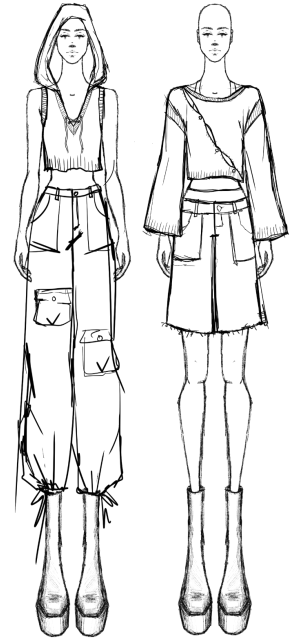
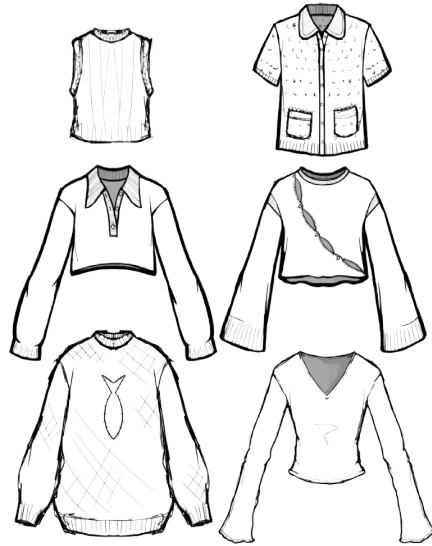
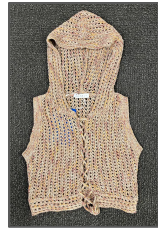



WOMENS SWEATERS

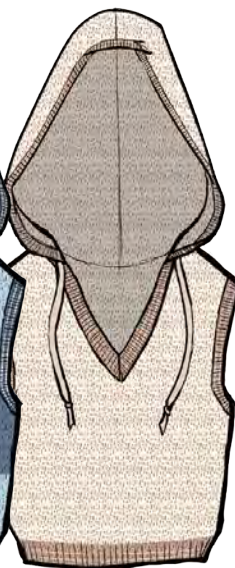
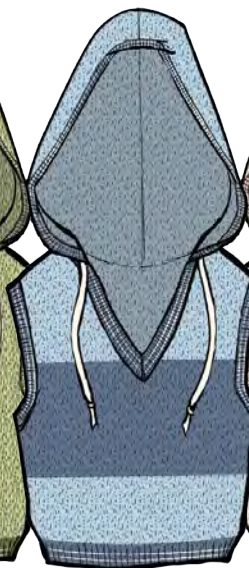
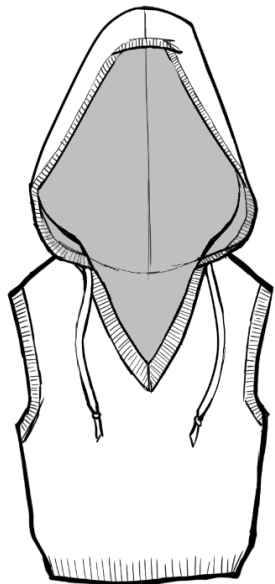



WOMENS SWEATERS

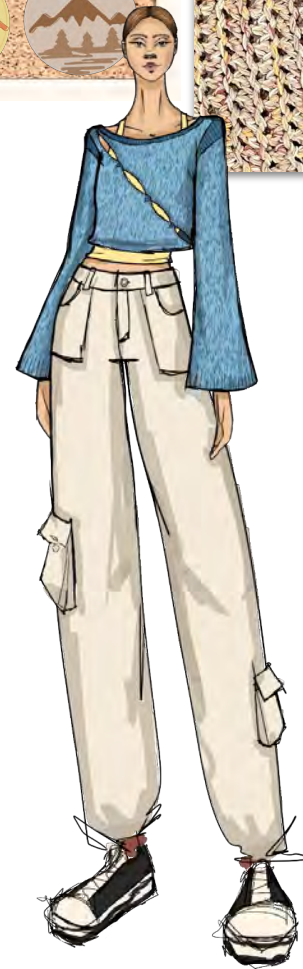
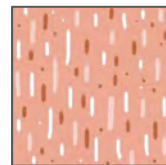
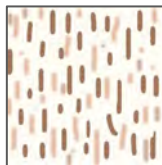
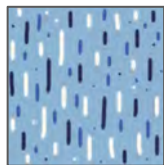
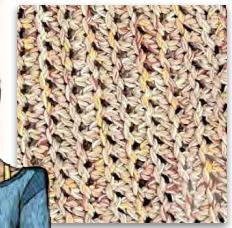



MENS WOVEN TOPS + SWIM



maxim
pockets



maxim
pockets

maxim
pockets

maxim
pockets



MENS WOVEN TOPS + SWIM

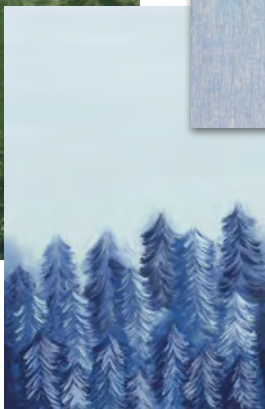
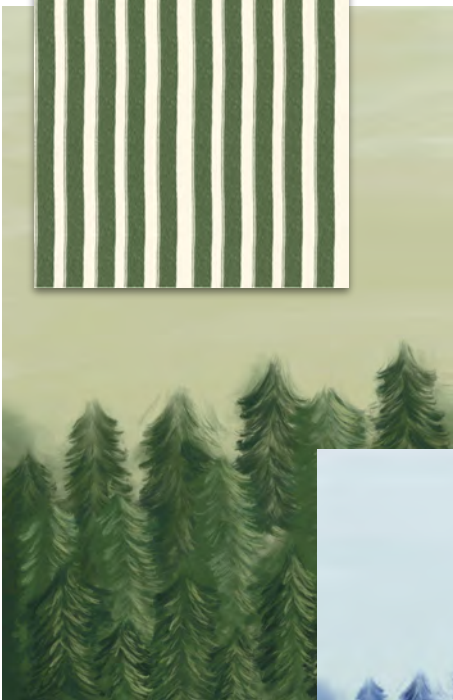



MENS WOVEN TOPS + SWIM

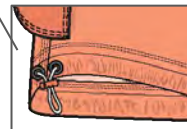
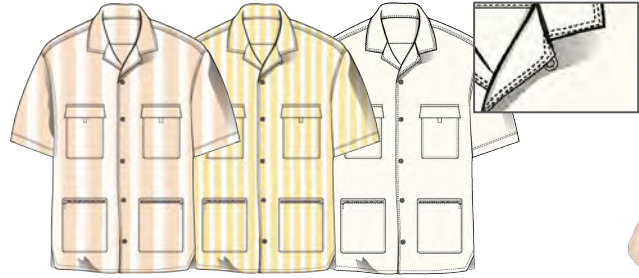



MENS KNIT TOPS



BUTTON SHIRT

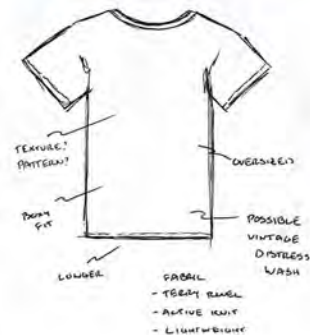
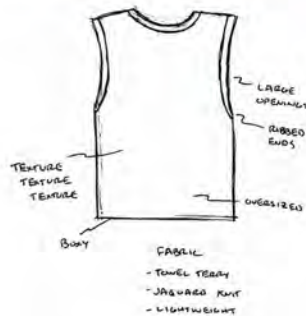
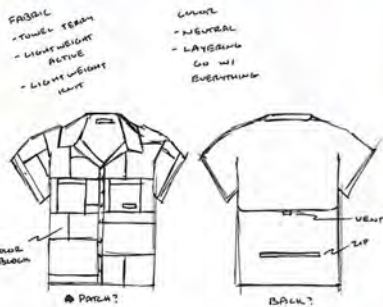
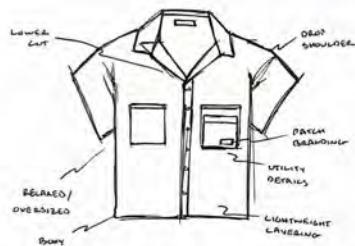

POCKETS



TWO ROWS



LOOP



DOUBLE



ZIPPER



CLASSIC



FLAP



30 POCKETS



4 POCKET

PATTERN / TEXTURE



[SURFACE FEEL]

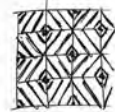

OVERSIZED VERSION W/ RAW ENDS



DISTRESSED ENDS



MENS KNIT TOPS

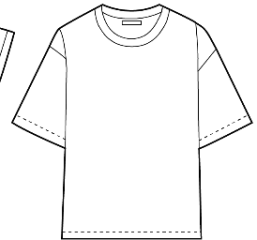
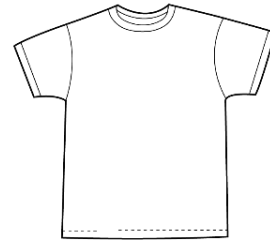
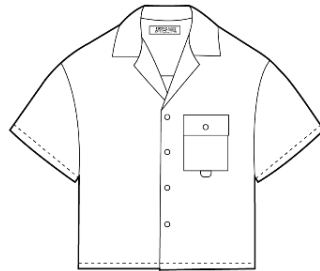
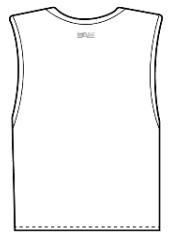
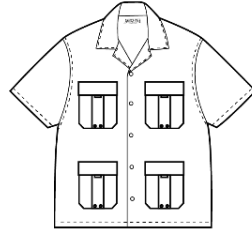
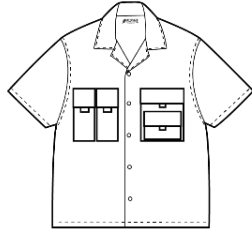
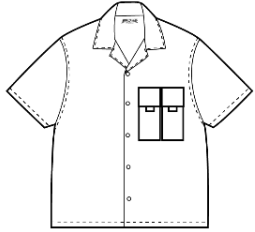
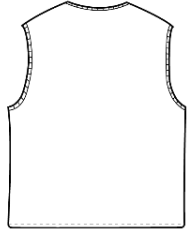
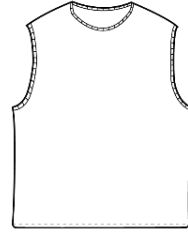
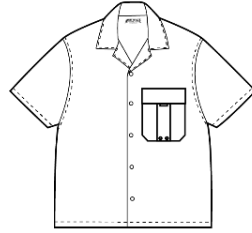

CAMP LIFE AMERICAN EAGLE CAMP LIFE CAMP LIFE

MENS KNIT TOPS

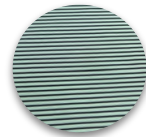
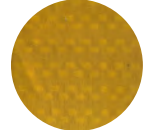
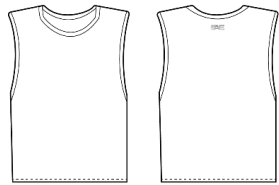
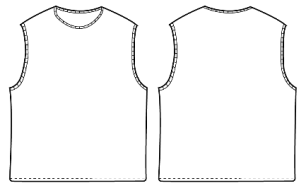



MENS FIT INSPO





MENS BOTTOMS



GEARED-TO-GO
RECYCLED NYLON
SHORT

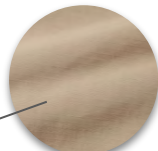

RECYCLED NYLON



6.5" INSEAM
LENGTH



8" INSEAM
LENGTH



COTTON CANVAS

COTTON CANVAS
HIKING SHORT



MENS BOTTOMS

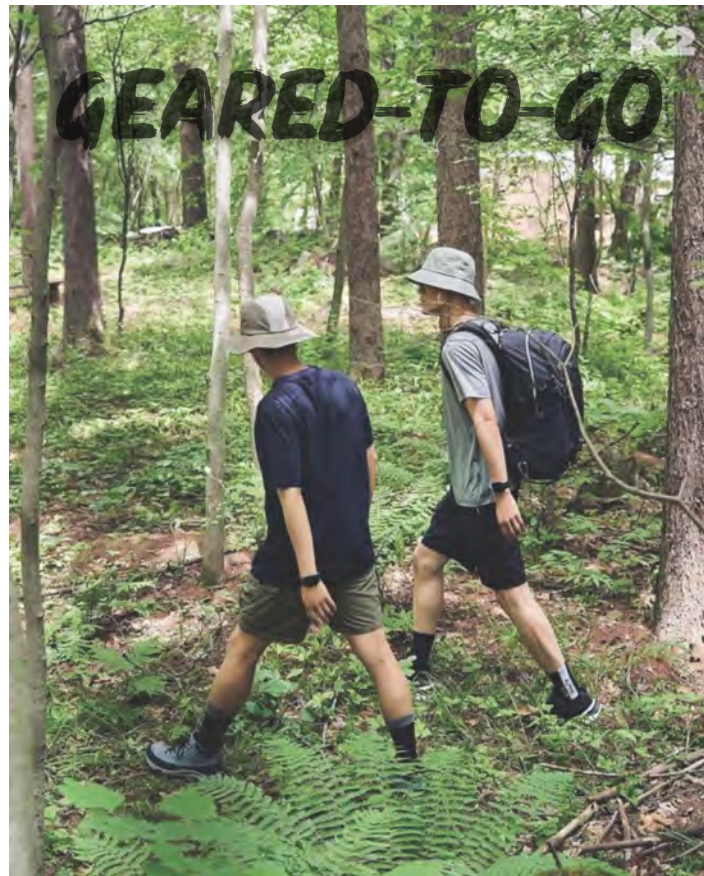

CAMP LIFE CAMP LIFE CAMP LIFE CAMP LIFE

MENS BOTTOMS





MENS STYLING



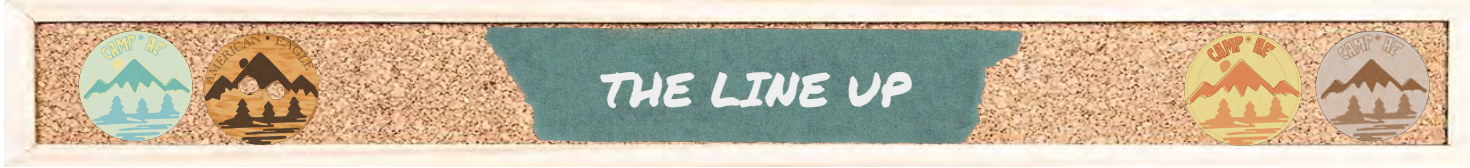



QUESTIONS?

